

HM10422

256-word x 4-bit Fully Decoded Random Access Memory

The HM10422 is ECL 10K compatible, 256-word x 4-bit, read write, random access memory developed for high speed systems such as scratch pads and control buffer storages.

Four active Low Block Select lines are provided to select each block independently.

The fabrication process is the Hitachi's low capacitance, oxide isolation method with double metalization.

The HM10422 is encapsulated in cerdip-24 pin package, compatible with Fairchild's F10422.

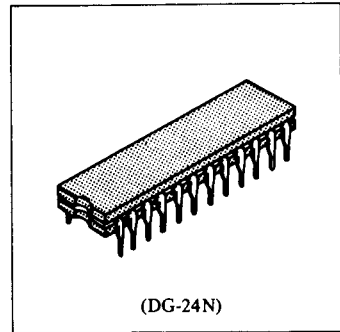

(DG-24N)

FEATURES

- 256-word x 4 bit organization.
- Fully compatible with 10K ECL level
- Address access time: 10ns (max)
- Write pulse width: 6ns (min)
- Power dissipation: 0.8mW/bit
- Output obtainable by wired-OR (open emitter)

TRUTH TABLE

Input			Output	Mode
BS	WE	Din		
H	X	X	L	Not Selected
L	L	L	L	Write "0"
L	L	H	L	Write "1"
L	H	X	Dout*	Read

Notes) X : Irrelevant
* : Read out noninvert

BLOCK DIAGRAM

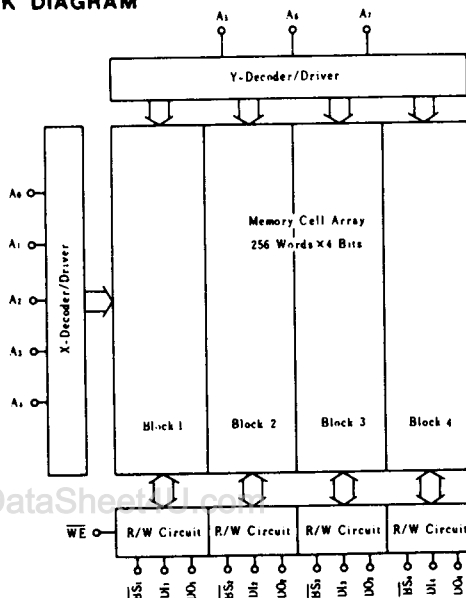

PIN ARRANGEMENT

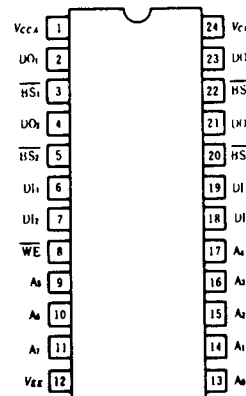

(Top View)

■ ABSOLUTE MAXIMUM RATINGS

Item	Symbol	Rating	Unit
Supply Voltage	V_{EE} to V_{CC}	+0.5 to -7.0	V
Input Voltage	V_{in}	+0.5 to V_{EE}	V
Output Current	I_{out}	-30	mA
Storage Temperature	T_{stg}	-65 to +150	°C
Storage Temperature	T_{stg} (Bias)*	-55 to +125	°C

* Under Bias

■ ELECTRICAL CHARACTERISTICS

($V_{EE} = -5.2V$, $R_L = 50\Omega$ to $-2.0V$, $T_a = 0$ to $+75^\circ C$, air flow exceeding 2m/sec)

● DC CHARACTERISTICS

Item	Symbol	Test Condition	min(B)	typ	max(A)	Unit		
Output Voltage	V_{OH}	$V_{IN} = V_{INA}$ or V_{ILB}	0°C	-1000	—	-840	mV	
			+25°C	-960	—	-810		
			+75°C	-900	—	-720		
	V_{OL}		0°C	-1870	—	-1665		
			+25°C	-1850	—	-1650		
			+75°C	-1830	—	-1625		
Output Threshold Voltage	V_{ONC}	$V_{IN} = V_{INB}$ or V_{ILA}	0°C	-1020	—	—	mV	
			+25°C	-980	—	—		
			+75°C	-920	—	—		
	V_{OLC}		0°C	—	—	-1645		
			+25°C	—	—	-1630		
			+75°C	—	—	-1605		
Input Voltage	V_{IH}	Guaranteed Input Voltage High for All Inputs	0°C	-1145	—	-840	mV	
			+25°C	-1105	—	-810		
			+75°C	-1045	—	-720		
	V_{IL}		0°C	-1870	—	-1490		
			+25°C	-1850	—	-1475		
			+75°C	-1830	—	-1450		
Input Current	I_{IN}	$V_{IN} = V_{INA}$	0 to +75°C	—	—	220	μA	
	I_{IL}	\overline{BS}	$V_{IN} = V_{ILB}$	0 to +75°C	0.5	—		170
		Other		0 to +75°C	-50	—		—
Supply Current	I_{EE}	All Input and Output Open, Test Pin 12	$T_a = 0^\circ C$	-200	-160	—	mA	
			$T_a = 75^\circ C$	—	-145	—		

● AC CHARACTERISTICS

1. READ MODE

Item	Symbol	Test Condition	min	typ	max	Unit
Block Select Access Time	t_{ABS}		—	—	5	ns
Block Select Recovery Time	t_{RBS}		—	—	5	ns
Address Access Time	t_{AA}		—	7	10	ns

2. WRITE MODE

Item	Symbol	Test Condition	min	typ	max	Unit
Write Pulse Width	t_w	$t_{WSA} = 2ns$	6	4.5	—	ns
Data Setup Time	t_{WSD}		2	0	—	ns
Data Hold Time	t_{WHD}		2	0	—	ns
Address Setup Time	t_{WSA}	$t_w = 6ns$	2	0	—	ns
Address Hold Time	t_{WHA}		2	0	—	ns
Block Select Setup Time	t_{WSBS}		2	0	—	ns
Block Select Hold Time	t_{WNBS}		2	0	—	ns
Write Disable Time	t_{WS}		—	4	5	ns
Write Recovery Time	t_{WR}		—	4.5	12	ns



3. RISE/FALL TIME

Item	Symbol	Test Condition	min	typ	max	Unit
Output Rise Time	t_r		—	2	—	ns
Output Fall Time	t_f		—	2	—	ns

4. CAPACITANCE

Item	Symbol	Test Condition	min	typ	max	Unit
Input Capacitance	C_{in}		—	4	—	pF
Output Capacitance	C_{out}		—	7	—	pF

■ TEST CIRCUIT AND WAVEFORMS

1. LOADING CONDITION

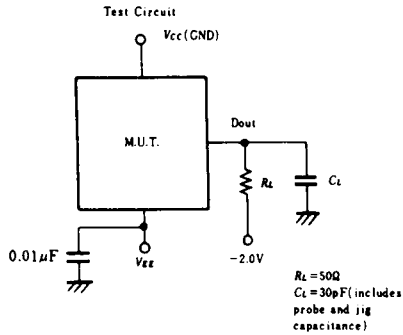

2. INPUT PULSE

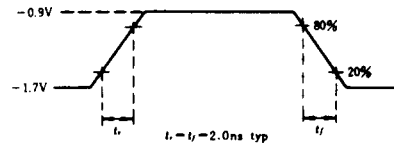

3. READ MODE

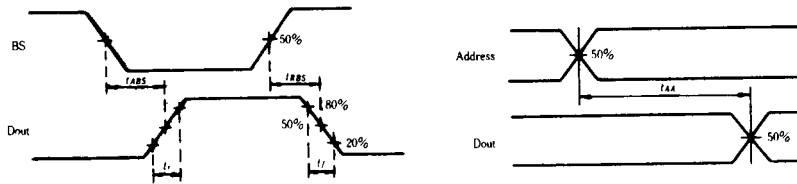

4. WRITE MODE

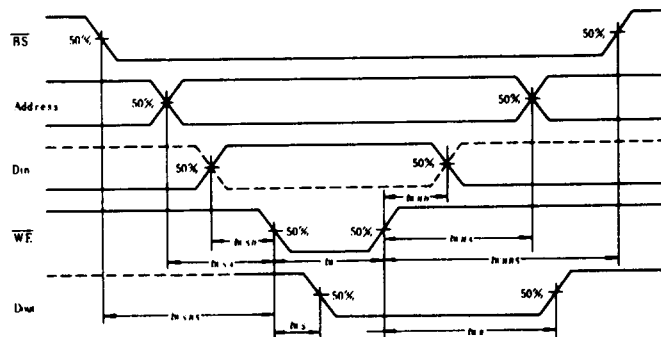

SUPPLY CURRENT vs. AMBIENT TEMPERATURE

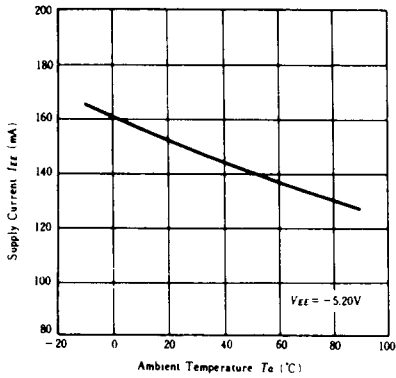

SUPPLY CURRENT vs. SUPPLY VOLTAGE

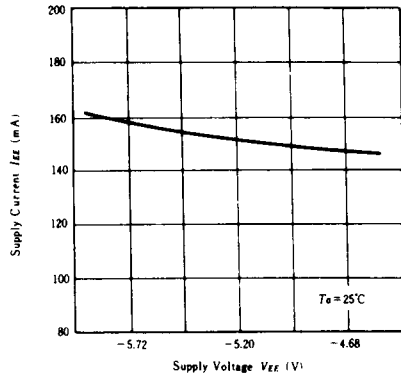

ADDRESS ACCESS TIME vs. AMBIENT TEMPERATURE

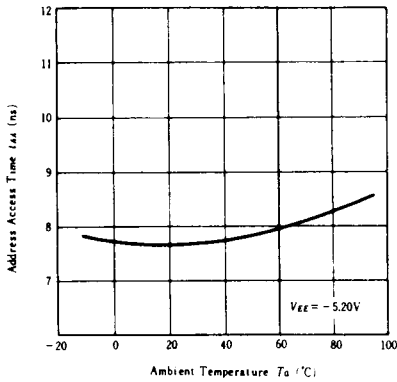

ADDRESS ACCESS TIME vs. SUPPLY VOLTAGE

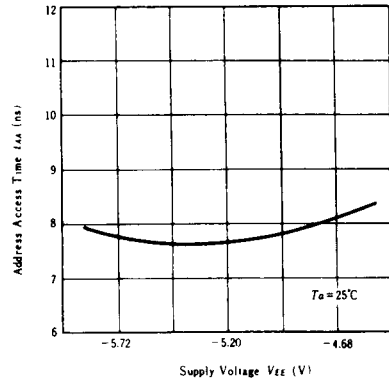

BLOCK SELECT ACCESS TIME vs. AMBIENT TEMPERATURE

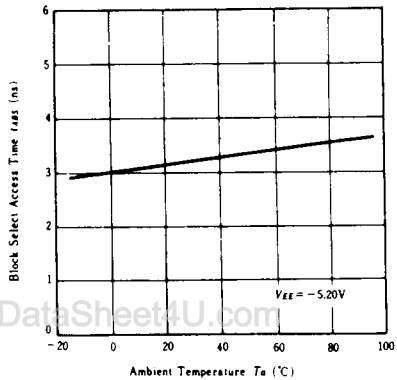

BLOCK SELECT ACCESS TIME vs. SUPPLY VOLTAGE

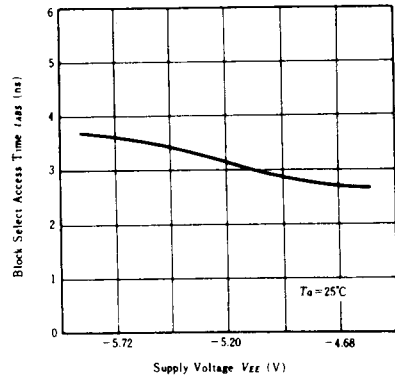

www.DataSheet4U.com



**WRITE PULSE WIDTH vs.
AMBIENT TEMPERATURE**

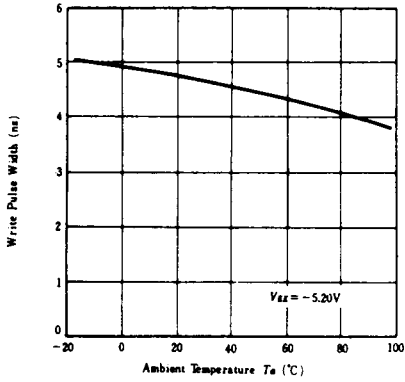

**WRITE PULSE WIDTH vs.
SUPPLY VOLTAGE**

